

# FAN-CLUB

## Nr. 8

### ZUM SAMMELN

#### CLUBMODELL: PNEUMATIC-COMBI-TRUCK

Bauvoraussetzungen für unseren PNEUMATIC-COMBI-TRUCK sind ein MASTER-Baukasten und ein Baukasten PROFI PNEUMATIC.

Die Modellidee könnt Ihr bestimmt auch verwirklichen, wenn Ihr nicht alle angegebenen Baukästen habt. Seht einfach in die Stückliste – und wenn Euch ein paar Teile fehlen, dann baut Ihr Euren eigenen PNEUMATIC-COMBI-TRUCK.

Wenn's gar nicht ohne Zusatzteile geht, gibf's die SUPER-SERVICE-Stationen oder den fischertechnik Einzelteil-Service, Tel. 0 74 43/12-369, Fax 0 74 43/12-591.



Download von:  
[www.ft-fanarchiv.de](http://www.ft-fanarchiv.de)

**fischertechnik**® ®



# Pneumatic Combi Truck

Fahrgestell und Lenkung siehe  
Bauanleitung Master / Motormaster Seite 8

1

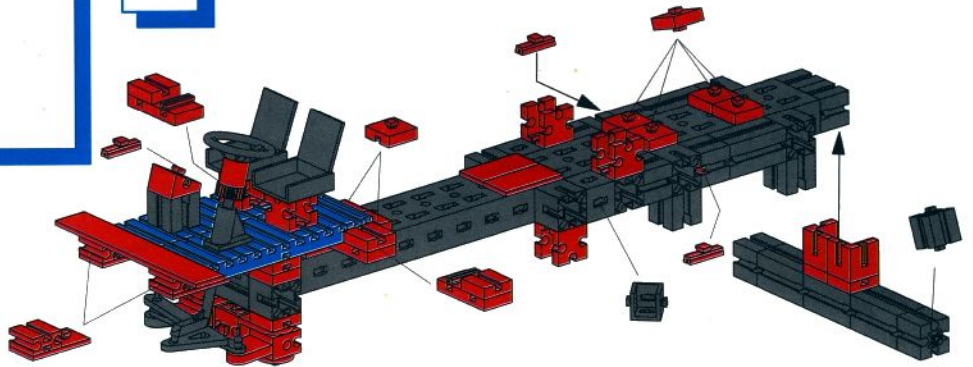

Kompressor siehe  
Bauanleitung Pneumatic Seite 10/11

2

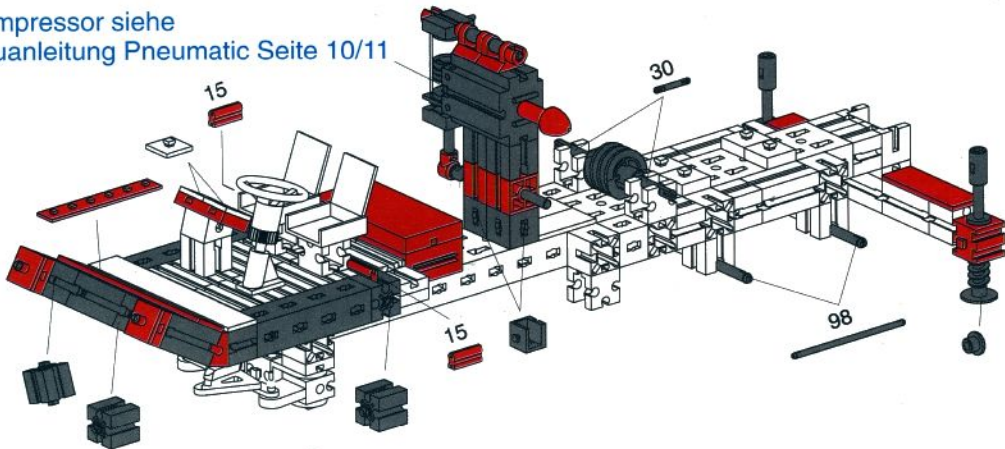

3

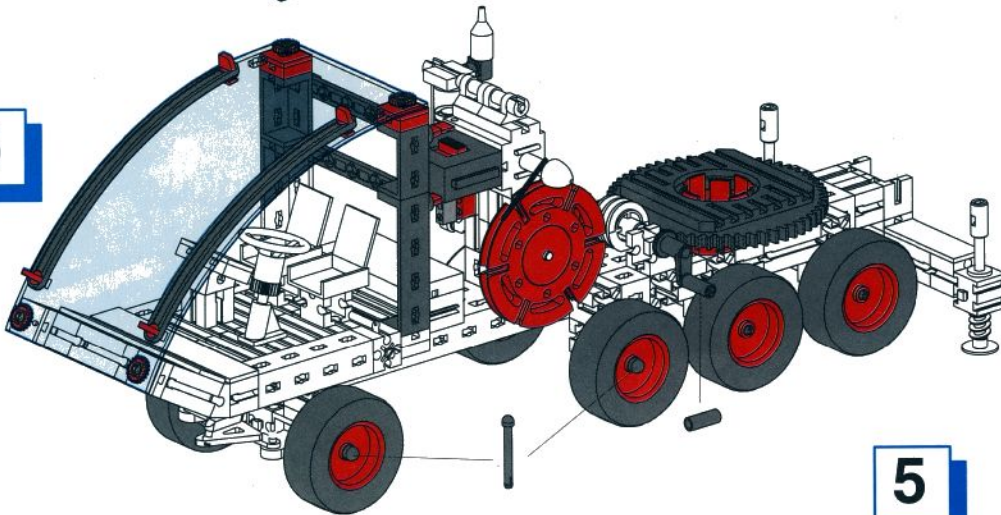

5

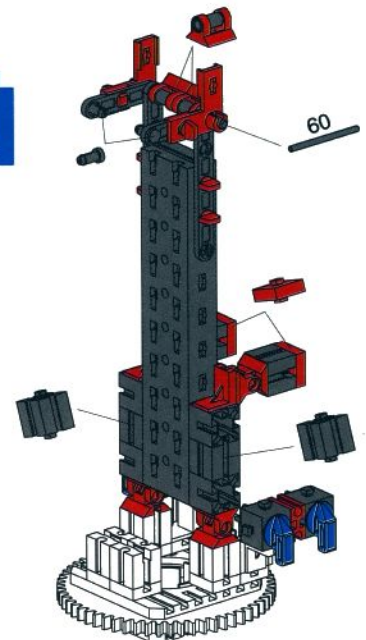

4

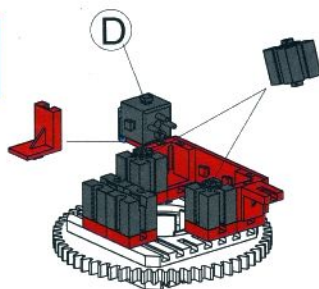

zu **6**

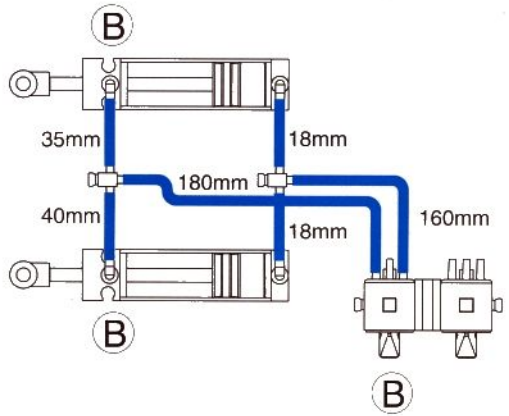

**6**

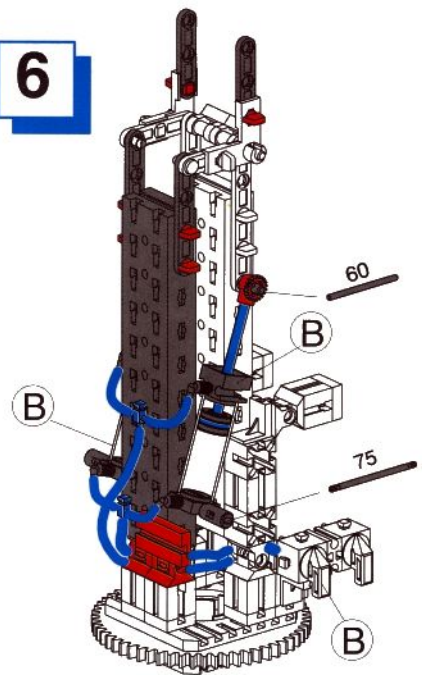

**7**

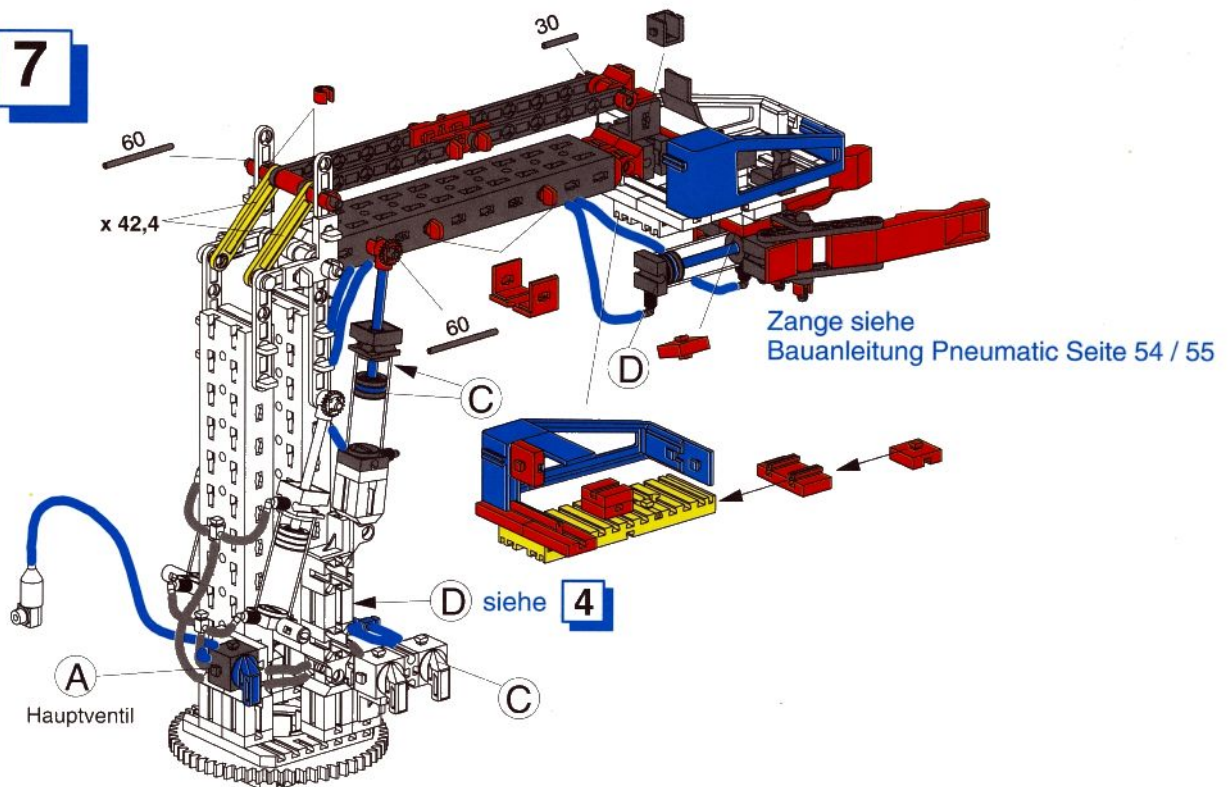



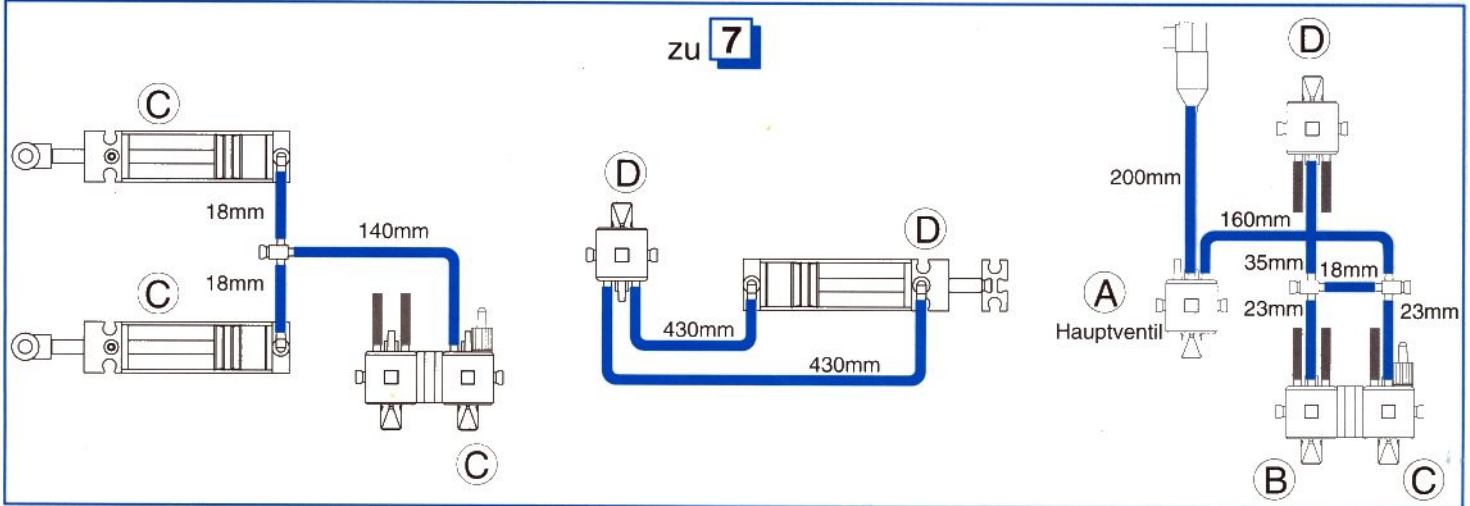























































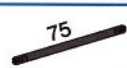











































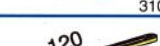



zu **7**





# Einzelteilübersicht

	Master/ Master Discovery	Profi Pneumatic		Master/ Master Discovery	Profi Pneumatic		Master/ Master Discovery	Profi Pneumatic		Master/ Master Discovery	Profi Pneumatic		
 31011	3x		 31854	1x		 32883	4x	4x	 36334	8x	 37238	8x	3x
 31019	1x		 31915	1x		 32884	1x		 36708	1x	 37468	4x	
 31032	1x		 31916	1x		 32885	1x		 36819	6x	 37636	6x	
 31060	5x		 31982	6x	2x	 32913	4x	4x	 36912	4x	 37679	10x	6x
 31061	1x		 31983	3x		 32958	1x		 36913	6x	 37681	1x	
 31140	1x		 31984	1x		 35031	1x		 36914	4x	 38240	4x	
			 31999	1x		 35049	3x		 36915	8x	 38241	4x	
 31390	1x		 32064	3x		 35063	2x		 36920	2x	 38242	2x	
 31391	1x		 32233	1x		 35072	1x		 36921	4x	 38245	2x	
 31422	5x		 32263	1x		 35073	4x		 36922	3x	 38246	2x	
 31426	2x	6x	 32293	1x		 35087	1x		 36923	6x	 38263	2x	
 31436	2x	11x	 32316	2x		 35088	1x		 36931	1x	 38267	2x	
 31597	5x		 32850	6x	8x	 35414	2x		 36934	4x	 38413	1x	
 31614	1x		 32852	1x		 35806	1x		 36937	1x	 38416	2x	2x
 31642	4x		 32854	2x	3x				 36938	5x	 38423	2x	3x
 31667	2x		 32860	2x		 35973	2x		 36949	1x	 38428	2x	2x
 31671	2x		 32861	1x		 35977	2x		 36950	2x	 38464	1x	
 31708	1x		 32870	2x	6x	 35978	2x		 36952	2x	 38542	2x	
 31766	2x		 32871	1x		 35979	2x		 36970	1x	 31058	1x	
 31771	4x					 35998	2x		 36977	1x	 36924	2x	
 31843	2x		 32879	4x	5x	 36026	6x		 36981	1x			
 31848	4x		 32881	8x	15x	 36132	2x		 37003	1x			
 31850	1x		 32882	4x	4x	 36323	28x		 37237	14x	13x		